



ASTROENERGY

---

# Installation Manual for Photovoltaic Modules



## Catalogue

<b>1</b>	<b>Introduction</b> .....	3
1.1	Purpose.....	3
1.2	Scope of liability .....	3
<b>2</b>	<b>Regulations</b> .....	3
<b>3</b>	<b>Safety Precautions</b> .....	3
3.1	General safety.....	4
3.2	Operation safety measures.....	5
<b>4</b>	<b>Handling, unloading and unpacking</b> .....	7
4.1	Transport and unloading .....	7
4.2	Demolition package.....	10
4.3	Stack .....	11
<b>5</b>	<b>Mechanical installation</b> .....	12
5.1	Environment .....	12
5.2	Tilt angle selection .....	13
5.3	Mounting Guide .....	13
5.3.1	Bolted mounting .....	14
5.3.2	Clamped mounting .....	15
5.3.3	Tracking bracket.....	24
<b>6</b>	<b>Electrical Installation</b> .....	25
6.1	Electrical characteristics.....	25
6.2	Electrical connection .....	26
6.3	Grounding.....	27
<b>7</b>	<b>Maintenance</b> .....	28
7.1	Routine Inspection.....	28
7.2	PV module cleaning .....	29
	<b>Modified version and date</b> .....	29



## 1 Introduction

We appreciate for your trust and confidence towards the photovoltaic (PV) module products manufactured by Astronergy.

Please read all instructions and the electrical and mechanical requirements in this manual carefully before installation. Specialized skills are required for installing and operating PV modules, and only professionals are capable to perform this task. All safety precautions in this manual shall be strictly observed during installation, and the manual shall be properly kept for further reference. The installer must inform the end customer (or consumer) accordingly.

### 1.1 Purpose

This document provides detailed instructions and safety precautions regarding the installation, electrical connection, and maintenance of following PV modules manufactured by Astronergy:

Table 1 This manual applies to photovoltaic module types

CHSM72M(DG)/F-BH	CHSM72N-HC
CHSM72M-HC	CHSM66N(DG)/F-BH
CHSM66RN(DG)/F-BH	CHSM60RN <sub>s</sub> (DG)/F-BH
CHSM60RN <sub>s</sub> (DGT)(BLH)/F-BH	CHSM54RN <sub>s</sub> (DG)/F-BH
CHSM54RN <sub>s</sub> (DG)(BLH)/F-BH	CHSM54RN <sub>s</sub> (DGT)(BLH)/F-BH
CHSM78N(DG)/F-BH	CHSM72N(DG)/F-HC
CHSM72N(DG)/F-BH	CHSM60N(DG)/F-HC
CHSM54N(DG)/F-HC	

### 1.2 Scope of liability

No warranty expressed or implied is made with regard to any information in this manual because how this manual is complied with is beyond the control of Astronergy. Astronergy shall not be liable for any form of loss, including but not limited to loss, damage, casualty or additional cost caused by improper installation, operation, use and maintenance of PV modules and systems.

Astronergy reserves the right to update this manual without prior notice. In case of any inconsistency between the description of different language versions of this manual, the Chinese version shall prevail.

## 2 Regulations

The mechanical installation and electrical connection of PV systems should be performed in accordance with local laws, regulations and corresponding international and domestic standards including electrical codes, building codes and electrical connection requirements. Such requirements may vary from different mounting location, e.g. rooftop system and floating systems. Requirements may also vary with system voltage and for DC/AC applications. Please contact local authorities for detailed governing regulations.

## 3 Safety Precautions

- Astronergy’s modules are designed to meet the requirements of IEC61215, IEC61730 and UL61730, and they have been qualified for Application Class A (equivalent to Safety Class II requirements). Modules can be applied to publicly accessible systems operating at greater than 50V DC or 240W.



## ASTRONERGY

---

- The double-glass module meets Class C fire rating (IEC61730) and type 29 fire rating (UL61730 for US market) or Class C fire rating (UL61730 for Canada market).
- The single-glass module meets Class C fire rating (IEC61730) and type 4 fire rating (UL61730).

### **! WARNING**

Read and understand all safety instructions before installing, wiring, handling, maintaining PV modules. PV modules generate direct current electricity when they are exposed to sunlight or other light sources. Whether the module is connected or not, direct contact with the live part of the module such as the wiring terminal may cause personal injury or even death.

### **3.1 General safety**

- Before installation, please contact the relevant local authority to make sure the installation permit and installation inspection requirements can meet the local requirements. The installation process should comply with the safety rules applicable to all components in the system, including cables, terminals, charging monitors, batteries, inverters, etc.
- Installation and maintenance must be completed by professionally qualified engineers. During the installation, wear safety helmets, insulating gloves, safety shoes and use insulating tools to avoid the direct contact with a DC voltage of 30V or even higher.
- It is forbidden to install the module on land < 50m away from the sea (please contact the technical team of Astronergy for evaluation and confirmation within 50m), and the connector needs to be protected or added the dust plug when installing the module in the area within 50~500m distance from the sea. Other anti-rust measures are also necessary to prevent the relevant components from rusting (please contact the technical team of Astronergy to confirm the specific protective measures). The modules must be connected immediately after removing the dust plug.
- During the installation and turnover of modules at the Project place, The rainproof measures should be taken to prevent the outer box from getting wet.
- When installing or operating PV modules on rainy days or dewy mornings, take appropriate protective measures to prevent moisture from penetrating the connectors.
- Unauthorized personnel are prohibited from approaching the installation area or PV module storage area.
- It is forbidden to install or use damaged PV modules.
- It is forbidden to repair PV modules by unauthorized personnel, including but not limited to replacing any part of PV modules (such as diodes, junction boxes, connectors, etc.).
- It is forbidden to plug in connectors of different types and models.
- It is forbidden to expose PV modules to the following substances: grease or organic ester compounds (e.g. DOP, plasticizers), aromatics, phenols, ketones, halogenated substances, mineral oil, alkanes (e.g. gasoline, cleaning lubricants,



electronic resurrection agents), alcohol, adhesive sheets that can generate oxime gas and potting glue (only for connectors), TBP (plasticizer), detergent, etc., to avoid chemical damage and affect the electrical safety performance of PV modules.

- Photovoltaic module installation is prohibited on windy days.
- Avoid focusing sunlight on PV modules.
- It is forbidden to place PV Modules where flammable gas may be generated.
- It is forbidden to install PV modules on movable platform, excepting tracking systems.
- It is forbidden to disassemble and move any part of the PV module; if the connector of the PV module is wet, do not perform any actions to avoid the risk of electric shock.
- It is forbidden to connect or disconnect the PV module when there is electrical current or external electrical current.
- The cover of the junction box should always be kept closed.
- The photovoltaic modules should be avoided to be partially shaded for a long time (it is recommended to confirm the installation environment before installation, such as: parapet walls, chimneys, skylights and other obstructions on the roof of the factory). and confirm whether there is dust and dusty areas in the installation environment (metal dust factory roof exhaust windows, chemical plants, etc.), to effectively avoid them, which will cause the temperature of the covered solar cells to rise (hot spot effect), as well as power generation loss. And in serious cases, the photovoltaic modules may be burned and even cause fire.
- For photovoltaic modules that are used in deserts, windy and sandy areas, water surfaces, or need long-term transportation and storage, it is recommended to use connector dust caps before installation, or take other measures to prevent sand and dust from entering the connectors, otherwise it may cause insertion problems or electrical safety hazards.
- After the modules are installed on the rack, it is recommended to plug in the connectors on the same day to prevent moisture or wind and sand from invading, causing mating or use problems.
- For wiring connections, please use standard PV copper wires with a cross-section area of at least 4mm<sup>2</sup>, and should be light-resistant and temperature-resistant at a minimum of 90°C.

### 3.2 Operation safety measures

- Avoid package damaging and falling during transportation and storage. Ensure the packing cases are well ventilated, water-proof and dry. After the arrival, carefully open the outer package and prevent scratches and bumps of PV modules.
- Avoid impact or scratches on any part of the PV module, otherwise the reliability and safety of the PV module will be affected; standing or walking on the PV module is prohibited; at the same time, in order to avoid glass damage, it is forbidden to apply excessive load or distorted PV modules.
- Do not install or carry PV modules by one person.



- It is forbidden to pick up, drag, or move PV modules by grabbing the junction box (including the box body, cables, and connectors); when placing a PV module on a flat surface, it must be operated carefully and be aware of bumps in the corners.
- When installing or repairing the PV system, do not wear any metal accessories to avoid the risk of electric shock; if it is installed far above the ground, please wear a seat belt.
  - When operating PV modules in the sun, please use insulated tools, and wear rubber gloves and protective clothing. At the same time, in order to avoid the risk of arc and electric shock, do not directly touch the junction box and the end of the output cable (connector) with bare hands.
  - For electrical connection, choose a dry and weak-light morning or evening; or use opaque materials to completely cover the surface of the PV modules to prevent current generation.
  - A certain distance between the PV module and the installation surface should be kept to prevent the installation surface from touching the junction box.
  - When installing on the roof, comply with the fire protection requirements of the building. It is recommended to install PV modules on a fireproof and insulated roof covering, and ensure adequate ventilation between the PV modules and the installation surface. In order to ensure the fire rating on the roof, the minimum distance between the frame of the PV module and the roof surface is 10cm.
  - The connectors must be fully mated when wiring. It is recommended to attach the cable to the C-side bezel or to the side of the bracket with a UV-resistant nylon cable ties to avoid connector detachment and direct sunlight. If the cable is too long, the bending radius of the wire should not be less than 48mm.
  - Avoid directly exposing cables and connectors to sunlight. Please use anti-UV cables.
  - Do not disconnect the electrical connection when there is a load.
  - It is strictly forbidden to try to disassemble the PV module, and it is strictly prohibited to remove the nameplate of the PV module or other parts on the PV module; it is strictly forbidden to paint or apply any adhesive on the surface of the PV module.
  - It is strictly forbidden to drill holes in the frame of the PV module.
  - It is strictly forbidden to scratch the anodized layer on the surface of the aluminum alloy frame, except when it is connected to the ground. Scratches may cause corrosion of the frame, affecting the frame's load-bearing capacity and long-term reliability.
  - If the PV module glass or other packaging materials are damaged, please wear personal protective equipment to separate the PV module from the site or the circuit. It is strictly forbidden to touch wet PV modules, unless you are wearing electric shock protection equipment that meets the requirements.
  - When professionals replace or repair PV modules, do not damage the surrounding PV modules or their



support structures.

- When cleaning PV modules, you must follow the cleaning requirements of PV modules.
- The connectors must be kept dry and clean to ensure that they are in good working condition. Do not insert other metal objects into the connector or make electrical connections in any other way.

#### **4 Handling, unloading and unpacking**

- If the PV module is not in use, please do not open the product packaging. The goods should be stored in a dark, dry and ventilated place.
- It is recommended to unpack an appropriate number of PV modules per day according to the project progress, and the unpacked PV modules should be installed within a day. If unpacking too many PV modules and being stacked on the ground, in severe weather such as heavy rain and typhoons, the PV modules may be immersed in water for a long time affecting the reliability of the product or be scraped away.

##### **4.1 Transport and unloading**

During the transportation of the PV modules to the project site, they must be packed in the packaging box provided by Astronergy, and they should be stored in the original packaging box before installation. Please protect the packaging from damage.

During the transportation of the project site with pothole or steep slope areas, the modules are prohibited from stacking, and only single pallet transportation is allowed. The packaging should be vertically upward during transportation.

It is necessary to ensure the safety when unloading PV modules, especially when hoisting roof projects. The PV modules should be placed in a protective device and then hoisted to the roof to prevent the packing box from deforming and bumping against the wall during the hoisting process.

There are three packaging methods for Module, Long-side vertical package、Short-side vertical package and U-shape package. The requirements for unloading and unpacking are also different. The packaging method is as follows:

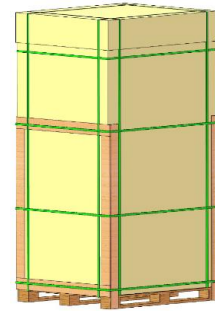

Long-side vertical package



Short-side vertical package

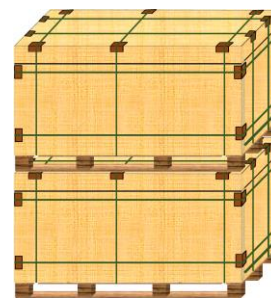

U-shape package



Matters needing attention for unloading with crane:

1. Use specialized equipment for crane operation. Select suitable hoisting equipment with enough strength according to the weight and the size of the load. Adjust the position of the sling to ensure the center of gravity is stable and keep moving at a stable speed. Place the package lightly on a flat ground and right the package.
2. Do not unload the modules under conditions of wind over class 6, rain and snow.
3. For Long-side vertical packages, do not lift up more than 2 pallets of modules at once. For Short-side vertical packages and U-shape packages, do not lift up more than 2 pallets of modules at once. For lateral unloading, remove the pallet stacking belts before unloading.

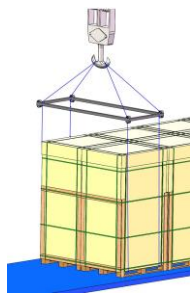

Hoisting equipment



Long-side vertical package unloading with crane

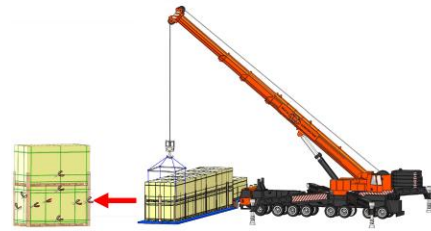

Short-side vertical package and U-shape package unloading with crane

Matters needing attention for forklift unloading:

1. Unload from both sides of the truck.
2. Select a suitable tonnage forklift according to the module weight, the fork distance should be adjusted to the maximum position without any interference to the pallet, the forks should go into the pallet at least 3/4 of the pallet depth during unloading (the forks length  $L \geq 3/4$  of pallet length), But do not hit other PV modules. the backrest height should be not less than 1.7m and the backrest width should be not less than 1.5m
3. The contact position between the backrest and the module package should be fixed with a buffer material (preferably silicone, rubber, EPE) to prevent the forklift from damaging the modules.
4. Since the packing box will block the sight of the forklift driver, it is recommended to drive backwards during the fork-lifting, and arrange for special supervision and command to prevent bumping into people or items causing personal injury or damage to the modules.





Long-side vertical package unloading with forklift



Short-side vertical package and U-shape package unloading with forklift

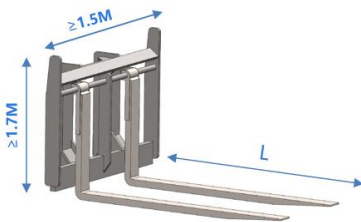

Backrest: height  $\geq 1.7\text{m}$ , width  $\geq 1.5\text{m}$

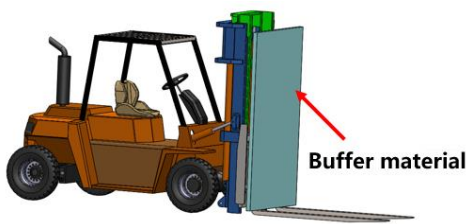

Cushion materials in front of the backrest

**! Special instructions**

Due to the limitation of the height of the container, when the photovoltaic modules are removed from the container, the distance between the upper surface of

the forklift tines and the ground should be less than 50mm, otherwise collisions may easily occur, which may damage the photovoltaic modules. Unload the front-most package in turn.

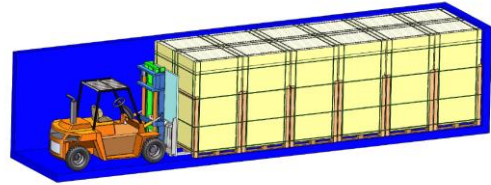

Unloading from container

Packaging turnover points are as follows:

1. When transporting the Long-side vertical packages, the entire module package shall prop against the backrest, backrest shall perpendicular to the fork, and the structure must be firm (withstand pressure  $\geq 1.5\text{ ton}$ ). When the entire module package leans on the backrest, the backrest shall not be deformed due to the pressure. the package must be fixed using a safety rope with tensile strength of  $\geq 2000\text{kgf}$ , and place safety guardrail on both sides of the forklift.
2. The forklift should be driven at a controlled speed of  $\leq 5\text{ km/h}$  in straight, and  $\leq 3\text{ km/h}$  for turning, so as to avoid sudden stop and rapid start
3. When using the hydraulic vehicle to transport the modules, the distance between the upper surface of the fork and the ground should be less than or equal to 75mm.
4. After the unpacking, the PV modules without fixed protection of packaging materials should not be transferred unless repacking, or a single piece of module could be transferred manually for a short distance.

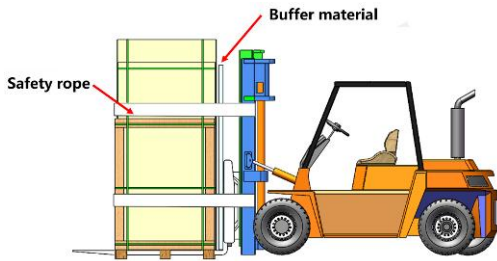

Forklift operation



Distance between the upper surface of the forklift tines and the ground

#### 4.2 Demolition package

Before unpacking, please make sure that the packaging box is in good condition, it is recommended to use art knife to remove the packing belt and wrapping film. Violent removal is prohibited to avoid scratching the modules in the box. It is strictly prohibited to unload modules under the weather conditions of wind speed greater than Level 6, heavy rain or heavy snow.

Please follow the recommended unpacking steps to unpack the modules. When unpacking, it must be operated by two or more people at the same time. Always wear insulating gloves when handling the modules.

1. Prepare the following tools before unpacking: art knife (scissors), safety hat, stand supporter, safety shoes and anti-cutting gloves.



Safety helmet



Pen knife



Stand supporter

2. Stand supporter must be used for Long-side vertical packaging unpacking, and the steps are as follows:

- 1) Remove the packing belts, wrapping film, top cover and carton box.
- 2) Place the stand supporter into the bottom of the pallet from the front or back side
- 3) Insert fixed bolts into the front hole of the support.
- 4) Cut off the horizontal packing belts.
- 5) Cut off the vertical packing belts excepting two inner belts.
- 6) push the module gently to tilt towards the stand supporter.
- 7) Cut the remaining packing belts.
- 8) tear off the anti-overturn tape on both sides by the thickness of one piece of module, and then take out the modules in order.

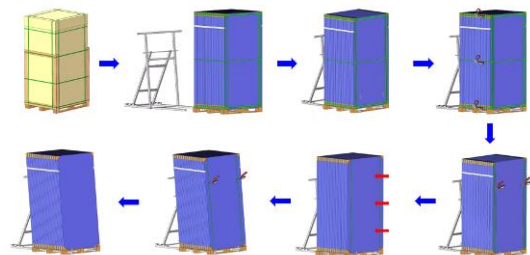

Long-side vertical packaging unpacking steps

3. Stand supporter is advised to be ready for Short-side vertical packaging unpacking, and the steps are as



follows

- 1) Remove the pallet stacking belts, wrapping film.
- 2) Cut off the packing belts, remove the top cover and carton box.
- 3) Place the stand supporter into the bottom of the pallet from the front or back side.
- 4) Insert fixed bolts into the front hole of the support.
- 5) Cut off the horizontal packing belts.
- 6) Cut off the vertical packing belts excepting two inner belts.
- 7) push the module gently to tilt towards the stand supporter.
- 8) Cut the remaining packing belts.
- 9) Take out the modules in order.

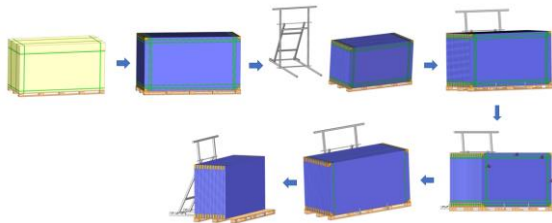

Short-side vertical packaging unpacking steps

(note: Contact Astronergy to obtain the drawings of dedicated Stand supporter.)

5. U-shape packaging unpacking steps are as follows
  - 1) Remove the pallet stacking belts, wrapping film.
  - 2) Cut off the packing belts, remove the top cover and carton box.
  - 3) Cut the inner packing belt.

- 4) Before taking out each time, tear off the anti-overturn tape on both sides by the thickness of one piece of module. While taking out the module, it is necessary to grasp the two short sides of the module together by two people, and then take out the module in order.

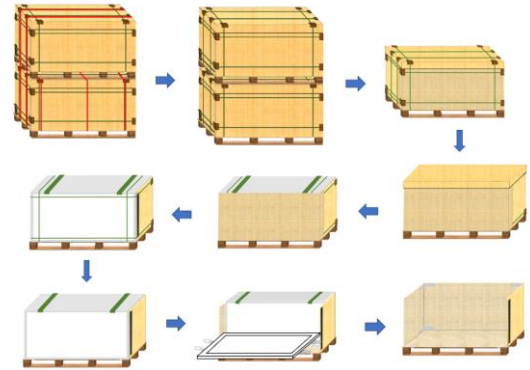

U-shape packaging unpacking steps

Note: the modules are strictly prohibited from colliding during turnover, storage, loading and unloading.



### 4.3 Stack

When taking out the PV module from the packing box, put the cardboard on the ground first to prevent the PV module from colliding and scratching with the cement surface, hard object on the ground, color steel tile, metal corrugated, etc.

When the PV modules are stacked, they must be neatly and stably stacked on a horizontal surface, and stacked with the front side of the bottom module facing up, the back side of other modules facing up, and placed on



the double pallets to be repacked. At the same time, there must be cardboard bedding under the PV modules, in order to prevent dumping, the number of piles should not exceed 14. At the same time, avoid installation tools and other objects on the surface of the PV module. The module must not be trampled or pressed under heavy pressure.

Secondary transportation of Modules packaged horizontally is prohibited.



Horizontal packing

Astronergy PV modules adopt high and low current bins, and the handlers need to place them separately and mark them according to the markings on the power list on the PV module outer packaging (for example, 670W-L means low current bin; 670W-H means high current bin; the current division method required by other customers is similar); According to the system design requirements, modules of the same current bin are usually required to be installed in the same array.

If the customer requires PV modules to be distinguished by color, the outer packaging box shall be marked accordingly, and the PV modules shall be marked to prevent confusion when they are taken out of the packaging box and stacked up. According to the system design requirements, the color of PV modules in the same row or the same array should be the same.

Modules should be stored in a dry and ventilated environment on a flat ground. Do not place modules

on soft ground to avoid damage or dumping of the modules due to ground deformation or collapse. Do not place modules on area with poor water drainage.

It is necessary that the modules must be stacked in strict accordance with the maximum number of layers printed on the box.

The packaged products should not be exposed to rain or moisture, they need to be put in a ventilated, rainproof and dry place.

For long-term storage, it is recommended to store the modules in a standard warehouse with regular inspection, reinforce the package in a timely manner if any anomalies are found.

Modules should avoid contact with corrosive substances such as acids and alkalis. The use of open flames is prohibited, and the warehouse shall be equipped with corresponding fire fighting facilities.

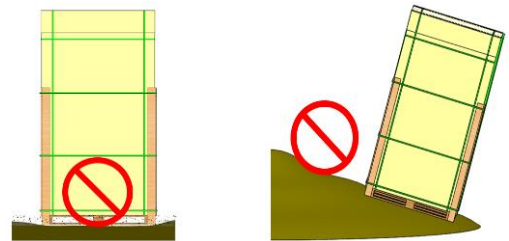

No soft ground and water

No inclination angle > 4°

## 5 Mechanical installation

### 5.1 Environment

- Recommended ambient temperature: -20°C to 50°C; extreme operating ambient temperature for PV modules: -40 °C to 85°C.
- If the operating temperature exceeds 70°C for more than 2% of the time in a year, please select the appropriate BOM in accordance with IEC TS



63126.

- The recommended maximum altitude for module installation is 2000m. If modules need to be installed at a higher altitude, please contact the Astronergy technical team in advance.
- Mechanical load on PV modules: under standard installation conditions, the maximum tested snow/wind load is 5400 Pa/2400 Pa and the design load (considering a safety factor of 1.5 times) is 3600 Pa/1600 Pa. Refer to 5.3 for detailed installation and mechanical loads.
- PV modules are strictly forbidden to be installed and used in environments with excessive amounts of hail, snow, hurricanes, sand, soot, air pollution, and etc. Astronergy's modules have passed the IEC 61701 Salt mist corrosion test for PV modules. And if PV modules need to be installed or used in environments where there are strongly corrosive substances (e.g. salt, salt spray, brine, active chemical vapors, acid rain, strong vapor confined environments or any other substance that will corrode PV modules and affect their safety or performance), please consult Astronergy technical team in advance.
- If the PV modules will be installed in special environments such as high temperature and high humidity environments, humid salt-mist environments (C3+areas specified in ISO 9223), marine and floating environments and farms, the purchaser or user needs to inform Astronergy in advance. The types of PV modules, BOM, and warranty issues will be decided by mutual agreement between the parties.

- If the above precautions are not observed, Astronergy's warranty will be void.

### 5.2 Tilt angle selection

The tilt angle of a PV module refers to the angle between the surface of the PV module and the ground surface, as shown in Fig. 1. The power output of a PV module is maximized when it faces the sun directly.

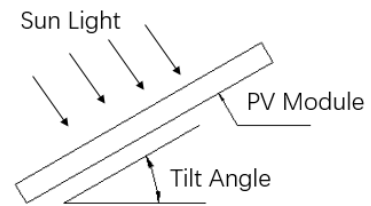

Fig. 1 Schematic diagram of tilt angle

For northern hemisphere, PV modules should preferably face south. For southern hemisphere, PV modules should preferably face north. For detailed mounting inclination, please follow local regulatory guidelines or the recommendations of an experienced installer.

PV modules connected in series should be installed in the same orientation and angle. Different orientations and angles may result in different amounts of solar radiation being received by each module, resulting in power loss.

### 5.3 Mounting Guide

- PV module mounting system must be composed of durable, corrosion-resistant and UV-resistant materials, and it must be inspected and tested by a third-party testing organization with static mechanical analysis capabilities meeting national and regional regulations or corresponding international standards.



- The PV module must be securely fastened to the mounting system. If the PV module is mounted in a snowy area, the height of the mounting system should be designed in a way that the lowest end of the PV module is not covered by snow. In addition, it should be ensured that the lowest end of the PV module is not shaded by surrounding trees or other vegetation.
- When the PV module is mounted on a rack parallel to the roof, the minimum clearance between the PV module frame and the roof is 10cm, which is necessary for air circulation to prevent wiring damage of the PV module.
- The PV module frame will suffer thermal expansion and contraction effect, therefore the space between two adjacent PV module frames should be no less than 10mm when mounted.
- For special installation areas (such as high altitude, mountain tops, coastal areas, wind vents), project sites with frequent strong winds, it is recommended to use square gaskets, anti-loosening nuts, anti-loosening gaskets, thickened gaskets, etc.
- Geographical location, installation conditions, system design and installation factors can affect modules operating temperatures. These influences must be considered when designing the system to ensure that modules are installed and used properly and that operating temperatures do not exceed the limits (See IEC TS 63126 for details of installation methods and regional restrictions).
- System design must consider module size tolerance, as specified in the module assembly drawings. For further details, please consult the Astronergy

technical team.

- For specific installation methods, please refer to the following installation specifications, If inappropriate fixtures or incorrect installation methods are used, the warranty of Astronergy will be invalid.

### 5.3.1 Bolted mounting

All PV modules must be secured with at least 4 bolts. The specific corresponding airborne values are shown in Table 2.

#### **! ATTENTION**

In order to achieve maximum safety precautions against wind and snow loads, it is recommended that all available mounting holes should be used. The bolt installation steps are as follows (Fig. 2).

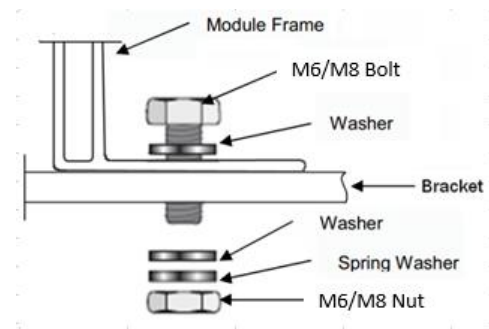

Fig. 2 Diagram of the bolt installation process

- ① Place the PV module on top of the rack.
- ② Insert 4 bolts in corresponding mounting holes. The 9x14mm mounting holes match with M8 bolts, while the 7x10mm mounting holes match with M6 bolts. 7x10mm mounting holes are positioned with a hole pitch of 400mm.
- ③ Make sure to use two washers for each bolt, one on



each side of the rack, the minimum thickness of the washer is 1.5mm, and the outer diameter is 16~18mm, but for 2384\*1303mm size modules, the outer diameter is 18~20mm, then screw on the top of a spring washer or toothed lock washer. Finally, lock with a nut. The tolerance requirements for flat gaskets are in accordance with the A-level standard in GB/T 3103.3-2020

- ④ The tightening torque is recommended to be 9~12Nm for M6 bolts and 17~20 N•m for M8 bolts. Due to the possible difference of bolt material, the specific torque value is subject to the information confirmed by the bolt supplier.
- ⑤ When using 30mm height frame module, it is recommended to select fasteners  $\leq 20$ mm length.
- ⑥ The fastener material shall be selected from Q235B or SUS304, depending on the local environment.

### 5.3.2 Clamped mounting

When PV modules are installed, each PV module must be fixed with at least 4 presses, as shown in Figures 3、4、5、6.

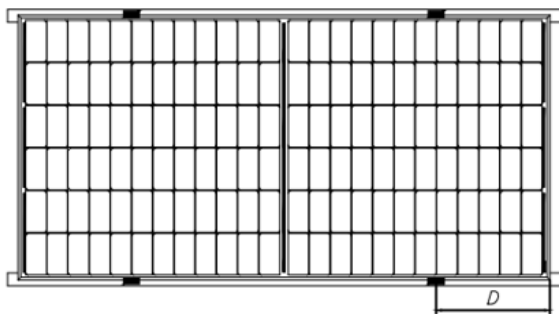

Fig.3 Rails overlapping the long-side frame

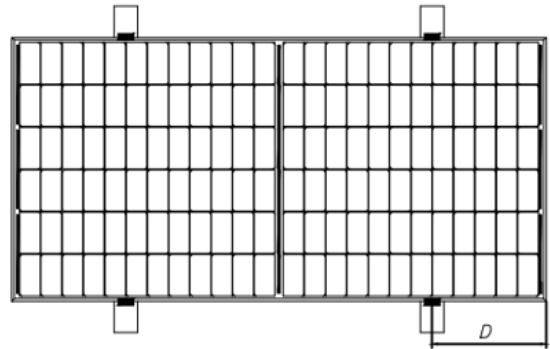

Fig. 4 Rails vertical to the long-side frame

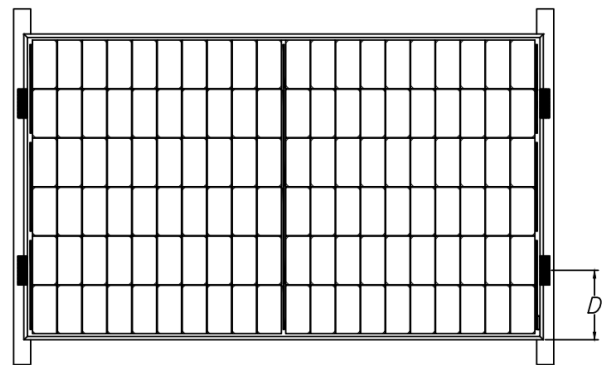

Fig. 5 Rails overlapping the short-side frame

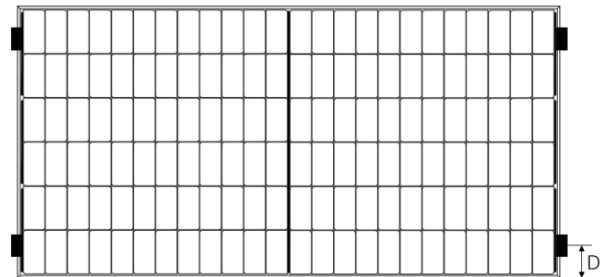

Fig. 6 Four clamp mounting on short side of frame

### ! ATTENTION:

- The length of the rack must be longer than the PV module, otherwise it should be confirmed by Astronergy in advance.
- The above two diagrams show the mounting



method using aluminum clamps. "D" indicates the mounting range. Table 3 shows the recommended mounting position and corresponding machine loads.

- Each aluminum clamp is equipped with an M8 bolt, two flat washer, a spring washer and an M8 nut. The mounting steps are as follows:

① Place the module on the two supporting rails (not provided by Astronergy) which should be made with stainless material and treated with an anti-corrosion process (e.g. hot dipped galvanizing). Each PV module needs at least four clamps to be fixed. The module clamps should not come into contact with the glass and should not deform the frame, otherwise they may cause module damage.

② Be sure to avoid shadowing effects from the module clamps. Weep holes on the module frame must not be closed or obscured by the clamps. The clamp must have an overlap of 8-11mm with the frame of the module and should not extend beyond it (The clamp section can be changed under the premise of ensuring reliable installation).

③ The top surface of the rail contacted with module frame should be equipped with grooves compatible with an M8 bolt.

④ If the grooves are not provided, holes of a suitable diameter may need to be drilled to allow bolts attaching to the rail at the same locations as mentioned above.

⑤ Ensure that the mounting sequence of each clamp is in the order of flat washer, spring washer and nut.

⑥ Figures 7 and 8 show the schematic diagram of the

clamp, while Figures 9 and 10 show the installation schematic diagram of the clamp. The dimensions of the clamp are as follows: Length(a)≥50mm, with a thickness of at least 4mm, and an overlap with the frame (d) ≥ 10mm; or Length(a)≥60mm, with a thickness of at least 3mm, and an overlap with the frame (d) ≥ 8mm. The clamp section can be changed under the premise of ensuring reliable installation, and it must not extend beyond the frame to avoid contact with the glass.

⑦ Modules sized 2384\*1303mm and above are only suitable for a clamp dimension of length(a) ≥ 60mm.

⑧ The tightening torque is suggested to be 17~23N•m for Class 8.8 screw and bolts.

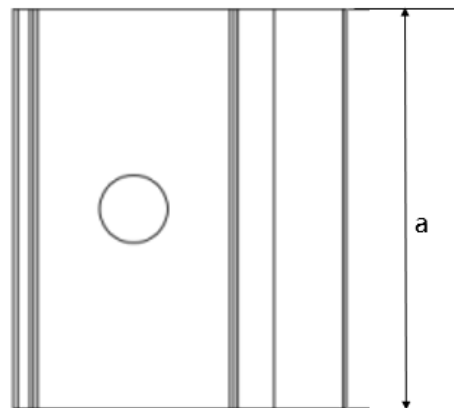

Fig. 7 Top view of fringe clamp

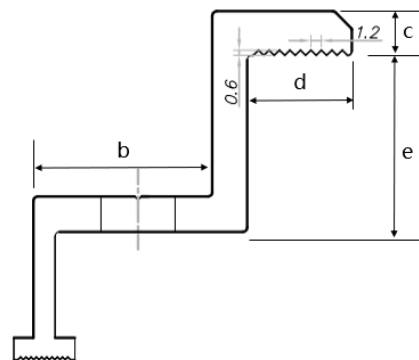





Fig. 8 Cross section diagram of fringe clamp

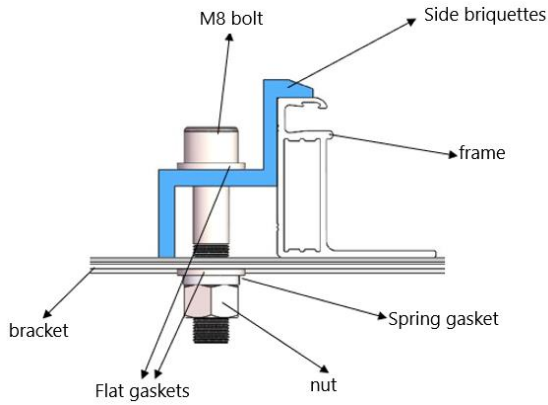

Fig. 9 Installation schematic diagram of fringe clamp

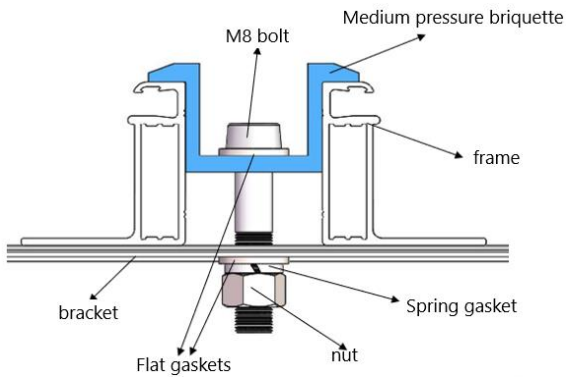

Fig. 10 Installation schematic diagram of mid clamp

⑨ To prevent modules from coming off the fixed device after installation, it is suggested to choose fringe and mid clamps and make contact with the A side of the frame with groove patterns. Suggest to have 9 patterns with a space between 2 adjacent patterns of 1.2mm and a depth of 0.6mm, as shown in figure 8.

⑩ For the mounting shown in Figure 3, the overlap between the C surface of the module and the rail should be  $\geq 25\text{mm}$ . Astronergy's limited warranty will be void if improper clamps or improper installation is used.



Table 2 Bolt installation diagram and corresponding mechanical load value

Module type	Module size L*W*H (mm)	Installation diagram	Load value
CHSM54N(DG)/F-HC	1722*1134*30	 <p data-bbox="778 674 1318 748">Long side frame with 4 bolts mounting (990mm holes), guide rails vertical long side frame</p>	+5400Pa -2400Pa
		 <p data-bbox="778 1048 1318 1122">Long side frame with 4 bolts mounting (990mm holes), guide rail coincides long side frame</p>	+3600Pa -2400Pa
CHSM54RN <sub>s</sub> (DG)(BLH)/F-BH CHSM54RN <sub>s</sub> (DGT)(BLH)/F-BH CHSM54RN <sub>s</sub> (DG)/F-BH	1762*1134*30	 <p data-bbox="772 1424 1326 1498">Long side frame with 4 bolts mounting (1100mm holes), guide rails vertical long side frame</p>	+5400Pa -2400Pa
		 <p data-bbox="772 1798 1326 1872">Long side frame with 4 bolts mounting (1100mm holes), guide rail coincides long side frame</p>	+3600Pa -2400Pa



Table 2 (Renewal)

Module type	Module size L*W*H (mm)	Installation diagram	Load value
CHSM60N(DG)/F-HC	1908*1134*30	 <p data-bbox="751 689 1362 757">Long side frame with 4 bolts mounting (1100mm holes), guide rails vertical long side frame</p>	+5400Pa -2400Pa
		 <p data-bbox="751 1084 1362 1151">Long side frame with 4 bolts mounting (1100mm holes), guide rail coincides long side frame</p>	+3600Pa -2400Pa
CHSM60RN <sub>s</sub> (DG)/F-BH CHSM60RN <sub>s</sub> (DGT)(BLH)/F-BH	1961*1134*30	 <p data-bbox="751 1460 1362 1527">Long side frame with 4 bolts mounting (1100mm holes), guide rails vertical long side frame</p>	+5400Pa -2400Pa

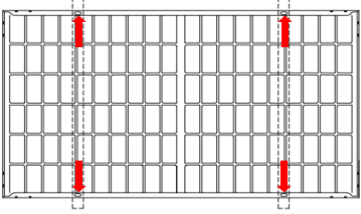
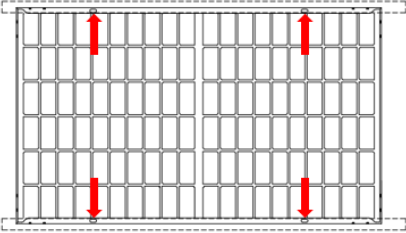
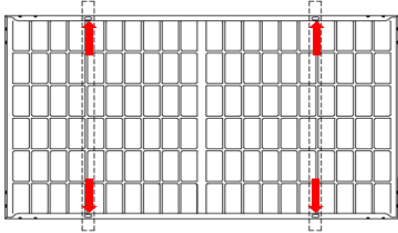
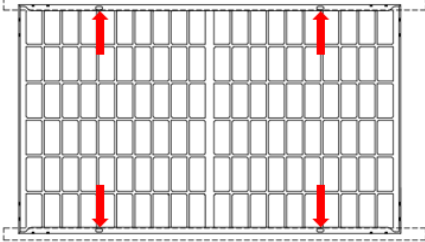

Table 2 (Renewal)



Module type	Module size L*W*H (mm)	Installation diagram	Load value
CHSM72M(DG)/F-BH CHSM72N(DG)/F-BH CHSM72N(DG)/F-HC CHSM66RN(DG)/F-BH	2278*1134*30 2278*1134*35 2382*1134*30	 <p data-bbox="740 723 1294 797">Long side frame with 4 bolts mounting (1400mm holes), guide rails vertical long side frame</p>	+5400Pa -2400Pa
		 <p data-bbox="740 1099 1294 1173">Long side frame with 4 bolts mounting (1400mm holes), guide rail coincides long side frame</p>	+3600Pa -2400Pa
CHSM66N(DG)/F-BH	2384*1303*33	 <p data-bbox="740 1473 1294 1547">Long side frame with 4 bolts mounting (1400mm holes), guide rails vertical long side frame</p>	+5400Pa -2400Pa
		 <p data-bbox="740 1850 1294 1917">Long side frame with 4 bolts mounting (1400mm holes), guide rail coincides long side frame</p>	+3600Pa -2400Pa

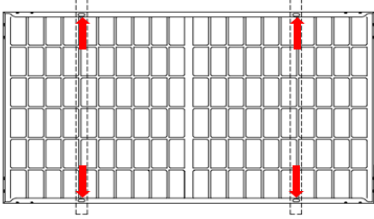
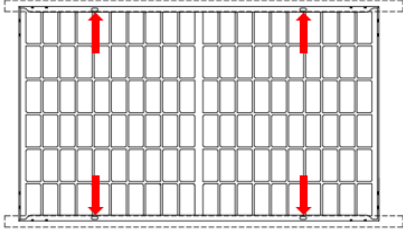
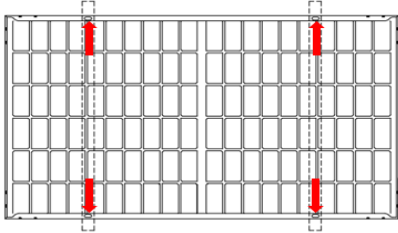

Table 2 (Renewal)

Module type	Module size L*W*H (mm)	Installation diagram	Load value
CHSM78N(DG)/F-BH	2465*1134*30	 <p data-bbox="742 680 1294 748">Long side frame with 4 bolts mounting (1500mm holes), guide rails vertical long side frame</p>	+5400Pa -2400Pa
	2465*1134*35	 <p data-bbox="742 1055 1294 1122">Long side frame with 4 bolts mounting (1500mm holes), guide rail coincides long side frame</p>	+3600Pa -2400Pa
CHSM72M-HC CHSM72N-HC	2278*1134*30 2278*1134*35	 <p data-bbox="742 1431 1294 1498">Long side frame with 4 bolts mounting (1400mm holes), guide rails vertical long side frame</p>	+5400Pa -2400Pa

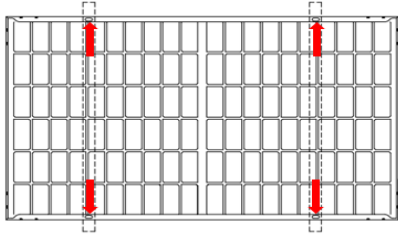
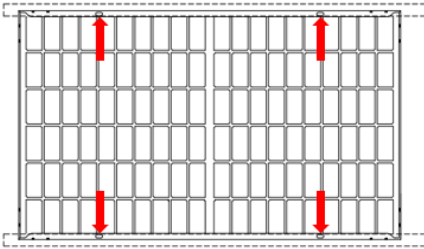
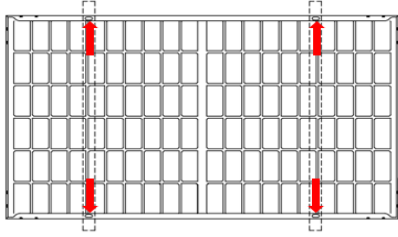
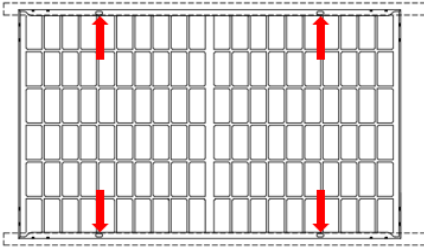
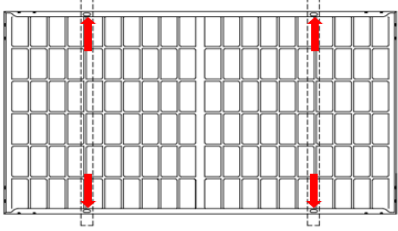
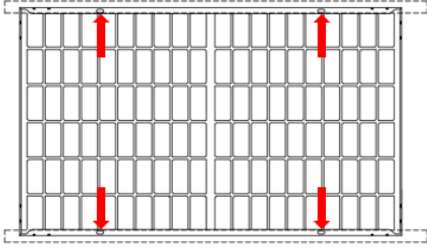
(Note: For other installation methods and load capacity not listed in the table, please contact Astronergy for confirmation.



Table 3 Range of clamp mounting and corresponding mechanical load value

Module type	Module size L*W*H (mm)	Refer to Figure 3 for installation method	Refer to Figure 4 for installation method	Refer to Figure 5 for installation method	Refer to Figure 6 for installation method
CHSM54N(DG)/F-HC	1722*1134*30	+3600Pa -2400Pa Mounting range D 266~466mm	+5400Pa -2400Pa Mounting range D 266~466mm	+1800Pa -1800Pa Mounting range D 150~250mm	+1200Pa -1200Pa Mounting range D 0~250mm
CHSM54RN <sub>s</sub> (DG)(BLH)/F-BH CHSM54RN <sub>s</sub> (DGT)(BLH)/F-BH CHSM54RN <sub>s</sub> (DG)/F-BH	1762*1134*30	+3600Pa -2400Pa Mounting range D 266~466mm	+5400Pa -2400Pa Mounting range D 266~466mm	+1800Pa -1800Pa Mounting range D 150~250mm	+1200Pa -1200Pa Mounting range D 0~250mm
CHSM60N(DG)/F-HC	1908*1134*30	+3600Pa -2400Pa Mounting range D 320~520mm	+5400Pa -2400Pa Mounting range D 320~520mm	+1800Pa -1800Pa Mounting range D 150~250mm	+900Pa -450Pa Mounting range D 0~250mm
CHSM60RN <sub>s</sub> (DG)/F-BH CHSM60RN <sub>s</sub> (DGT)(BLH)/F-BH	1961*1134*30	+3600Pa -2400Pa Mounting range D 320~520mm	+5400Pa -2400Pa Mounting range D 320~520mm	+1800Pa -1800Pa Mounting range D 150~250mm	+1200Pa -1200Pa Mounting range D 0~250mm
CHSM66N(DG)/F-BH	2384*1303*33	+3600Pa -2400Pa Mounting range D 450~550mm	+5400Pa -2400Pa Mounting range D 450~550mm	--	--
CHSM72M(DG)/F-BH CHSM72N(DG)/F-BH CHSM72N(DG)/F-HC	2278*1134*35	+3600Pa -2400Pa Mounting range D 400~500mm	+5400Pa -2400Pa Mounting range D 400~500mm	---	---
	2278*1134*30	+3600Pa -2400Pa Mounting range D 430~530mm	+5400Pa -2400Pa Mounting range D 430~530mm	---	---
CHSM66RN(DG)/F-BH	2382*1134*30	+3600Pa -2400Pa Mounting range D 470~560mm	+5400Pa -2400Pa Mounting range D 470~560mm	---	---
CHSM78N(DG)/F-BH	2465*1134*35 2465*1134*30	---	+5400Pa -2400Pa Mounting range D 480~530mm	---	---



Table 3 (Renewal)

Module type	Module size L*W*H (mm)	Refer to Figure 3 for installation method	Refer to Figure 4 for installation method	Refer to Figure 5 for installation method	Refer to Figure 6 for installation method
CHSM72M-HC CHSM72N-HC	2278*1134*30	---	+5400Pa -2400Pa Mounting range D 430-530mm	---	---
	2278*1134*35	---	+5400Pa -2400Pa Mounting range D 400-500mm	---	---

(Note: For other installation methods and load capacity not listed in the table, please contact Astronergy for confirmation.)



**5.3.3 Tracking bracket**

Astronergy’s modules can be matched and installed with the industry's mainstream bracket systems, and the matching test load is shown in Table 4.

Table 4 Installation diagram of the tracking bracket and corresponding mechanical load values

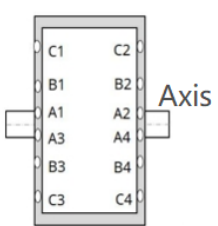
Installation method	Module type	Module size L*W*H (mm)	Bracket type	Mounting form	Load value
 <p>1P Tracking bracket<sup>①</sup></p>	CHSM66N(DG)/F-BH	2384*1303*33	NEXTracker	400mm Pore Distance M6 bolt +M6 Flat spacers (O.D.≥16mm)	+1800Pa/ -1800Pa
	CHSM66RN(DG)/F-BH	2382*1134*30		400mm Pore Distance M6 bolt +M6 Flat spacers (O.D.≥16mm)	+1800Pa/ -1800Pa
	CHSM78N(DG)/F-BH	2465*1134*30		400mm Pore Distance M6 bolt +M6 Flat spacers (O.D.≥16mm)	+1800Pa/ -1800Pa <sup>②</sup>
	CHSM72M(DG)/F-BH CHSM72N(DG)/F-BH CHSM72N(DG)/F-HC	2278*1134*30		400mm Pore Distance M6 bolt +M6 Flat spacers (O.D.≥16mm)	+2100Pa/ -2100Pa
		2278*1134*35		790mm Pore Distance M6 bolt +M6 Flat spacers (O.D.≥16mm)	+3200Pa/ -2400Pa
	CHSM72M(DG)/F-BH CHSM72N(DG)/F-BH CHSM72N(DG)/F-HC	2278*1134*30	Soltec	guide rail: 50*1.5*1450 (H*T*L/mm) Fix the hole position: 400+1400mm M6 bolt +M6 Flat spacers (O.D.≥16mm)	+2800pa/ -2400pa
		2278*1134*30 2278*1134*35	PVH	guide rail: 80*1.5*428 (H*T*L/mm) Fix the hole position: 400mm M6 bolt +M6 Flat spacers (O.D.≥16mm)	+1800Pa/ -1800Pa

(Note:

- ①: When the tracking bracket 1P is installed with 400 holes of the fixed module, the corresponding test load value is the transparent back glass component.
- ②: It is the maximum test load for this installation method. If this installation method or any other installation methods and load capacity that are not listed in the table are involved, please contact Astronergy for confirmation.)





## 6 Electrical Installation

### 6.1 Electrical characteristics

Module electrical ratings are measured under Standard Test Conditions(STC: 1000W/m<sup>2</sup> irradiance, AM1.5 spectrum and a cell temperature of 25°C). Please refer to the datasheet or the product nameplate for the main electrical characteristics, maximum system voltage and tolerance of Isc, Voc and Pmpp.

Under certain conditions, the output current and/or voltage of the PV module may be higher than the value under standard testing conditions. Therefore, the value of Isc marked on the module should be multiplied by 1.25, and Voc on the module should be multiplied by a correction factor (see table 5 below) when determining component ratings and capacities. Depending on your local regulations, an additional 1.25 multiplier for the Isc(giving a total multiplier of 1.56) may be applicable when sizing conductors and fuses.

For bifacial PV modules, the Isc is also influenced by the specific mounting conditions. The current varies with different mounting heights and surfaces with different reflectivities. The system design engineer should consider the effect of the backside irradiance of the module to the current, see IEC 61730 for details.

Table 5 Correction factor of Voc at low temperature

Lowest Estimated Ambient Temperature(°C)	Correction factor
24 ~ 20	1.02
19 ~ 15	1.04
14 ~ 10	1.06
9 ~ 5	1.08
4 ~ 0	1.10
-1 ~ -5	1.12
-6 ~ -10	1.14
-11 ~ -15	1.16
-16 ~ -20	1.18
-21 ~ -25	1.20
-26 ~ -30	1.21
-31 ~ -35	1.23
-36 ~ -40	1.25

Alternatively, a more accurate correction factor for the Voc can be calculated using the following formula:

$$C_{Voc}=1-\alpha_{Voc} \times (25-T_{min})$$

Where: C<sub>Voc</sub> is the correction factor of V<sub>oc</sub>. α<sub>Voc</sub> (%/°C) is the open-circuit voltage temperature coefficient of the selected module (refer to corresponding datasheet). T<sub>min</sub>(°C) is the expected lowest ambient temperature at the system installation site.

The string voltage must not be higher than the maximum system voltage, as well as the maximum input voltage of the inverter and other electrical



equipment installed in the system. To ensure the above requirements, the open-circuit voltage of the string needs to be calculated using the following formula:

$$\text{Maximum system voltage} \geq N * V_{oc} * C_{voc}$$

Where: N is the number of PV modules in a single string.  $V_{oc}$  is the open-circuit voltage of each PV module (refer to the nameplate or product datasheet).

**! ATTENTION**

Depending on the maximum fuse ratings of the PV module, and the local electrical installation standards, the connection of parallel strings of PV modules needs to be equipped with suitable fuses or preventive diodes for circuit protection purposes.

Please refer to the corresponding datasheets for the electrical specifications of the modules.

Electrical calculations and design must be performed by a competent engineer or consultant.

**6.2 Electrical connection**

To ensure the normal operation of the system, make sure the polarity of cables is correct when connecting modules or loads, such as inverters and batteries. If the PV module is not connected correctly, the bypass diode may be damaged. Fig. 11 shows how the PV modules are connected in series and parallel. PV modules can be wired in series to boost the voltage. Series connections are made by connecting the wire from the positive terminal of one module to the negative terminal of the next module. PV modules can be wired in parallel to increase the current by connecting the positive terminal of one module to the positive terminal of the next module. If a module is not

connected correctly, the bypass diode may be damaged.

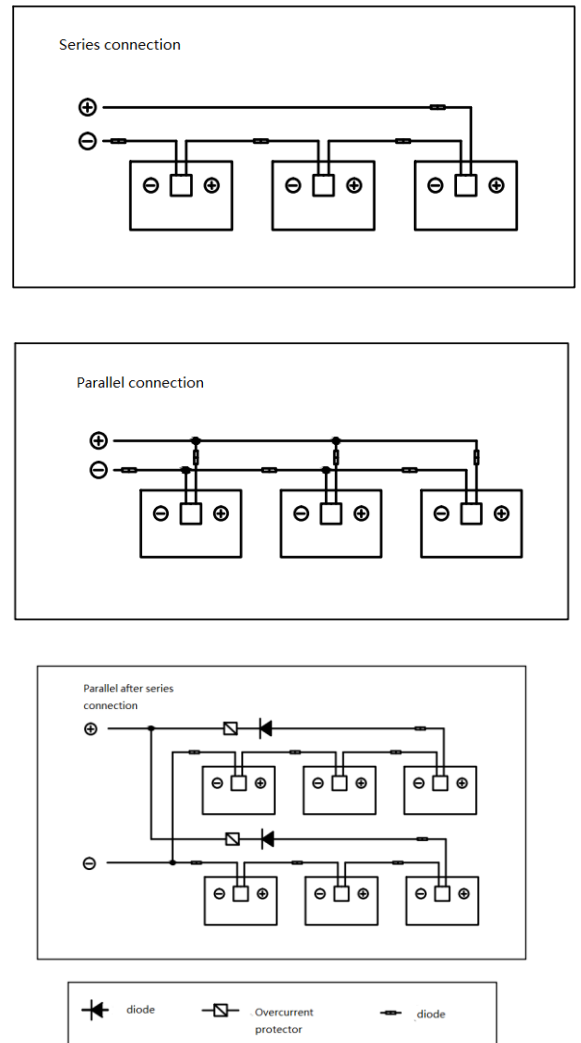

Fig. 11 Schematic diagram of electrical connection

**! ATTENTION**

- If one PV module string (or PV array) is connected to another with opposite polarity, irreversible damage can be caused to the PV module product. Be sure to confirm the voltage and polarity of each string before making a parallel connection. If measurements reveal opposite polarity or a voltage difference greater than 10V between the strings, check their structural configuration before



proceeding with the connection.

- The number of modules connected in series and parallel should be reasonably designed according to the system configuration. And if you have any questions, please contact the manufacturer
- In case there is a reverse current exceeding the fuse current rating, an overcurrent protection device of the same specification must be used to protect the module. Be aware that if there are two or more strings parallelly connected, there must be an overcurrent protection device on each string.
- PV modules with different electrical performance models cannot be connected in one string.
- The system shall use special cables and connectors for PV system and ensure that all connections are securely fastened. The cable must be 4mm<sup>2</sup> (i.e. 12 AWG) and withstand the maximum possible open-circuit voltage of the PV system.
- When fixing the cable to the rack, it is necessary to avoid mechanical damage to the cable or to the PV module. Do not press the cable hard. To secure the cable to the rack in the proper way, specially designed UV-resistant coils and cable clips must be used. Avoid direct sunlight and water soaking to the cable.
- Keep the connectors dry and clean and make sure that the nuts on the connectors are tightened before connecting them. Do not connect the connectors when they are damp, contaminated or in other bad conditions. Avoid exposing connectors to direct sunlight and soaking in water. Avoid the connectors falling on the ground or the roof. Do not plug or unplug the connectors when the PV module is in

live state. When it is necessary to remove the connectors, ensure that the PV module is not in working condition and that professional unlocking tools and safety measures are used. Direct dragging and pulling is forbidden.

- The junction box of the PV module contains bypass diodes connected in parallel to the string of the PV module. The bypass diode in the junction box prevents module degradation due to shading or covering. Refer to the junction box diode specification provided in the relevant product datasheet for more details. I When the localized hot spot phenomenon occurs in the PV module due to partial shading or coverage, the diode in the junction box will start to work, so that the module current will no longer flow through the hot spot cell, so as to limit the heat and loss of the PV module. When a diode failure is suspected or found, please contact Astronergy and do not attempt to open the junction box cover.

### 6.3 Grounding

The PV modules are designed with an anodised, corrosion-resistant aluminum alloy frame as a rigid support. To ensure safety and to avoid lightning strikes and electrostatic damage to the PV modules, the PV module frame must be earthed. The earthing device must be in full contact with the interior of the aluminum alloy of the frame, penetrating the surface oxide film. The following is the specific grounding method, as shown in Fig. 12.

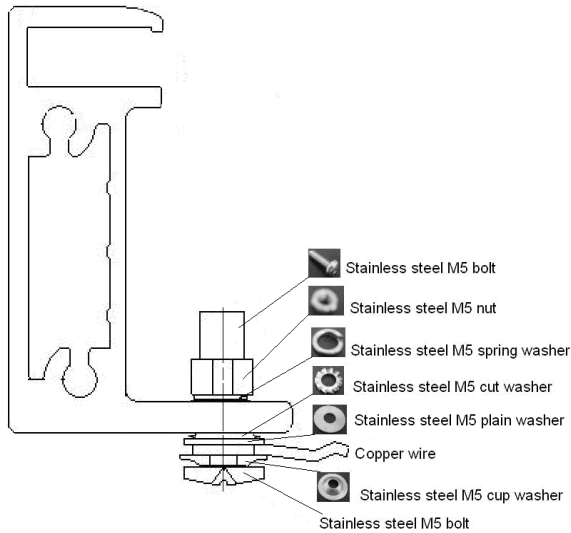

Fig. 12 Grounding the aluminum frame with copper wire

- The module frame must be grounded, and the grounding design needs to meet the requirements of relevant national, regional or international regulations, laws and standards.
- Use the marked 5.5 mm grounding holes to ground the anodized frame. Use one M5 nut, two M5 cut washers, one M5 plain washer, one M5 spring washer, and one M5 bolt and the copper wire. All nuts, bolts, and washers shall be of type M5 and made of stainless steel (Fig. 18).
- Insert the bolt through the cup washer and wrap the copper wire around the bolt. (Note that the copper wire cannot be attached directly to the aluminum.)
- Insert the bolt through the cut washer and then through the hole in the aluminum frame.
- Add the spring washer and nut on the other side of the bolt and tighten to secure all parts. The tightening torque should be 4~4.5N•m.

**! ATTENTION**

- If other grounding methods are required, the correct grounding system must be selected and must comply with the appropriate electrical codes. Make sure that the selected grounding method will not have any effect on the electrical power and product warranty of the modules, or the Astronergy Limited Warranty will be void.
- Do not drill any additional grounding hole on the frame of the modules. The unused mounting holes on the frame can also be used for grounding, but it is necessary to use grounding accessories that match the specifications of the holes. The accessories must ensure that the piercing is effective and that the grounding resistance meets the grounding requirements.
- The frame rails have pre-drilled holes marked with a grounding sign. These holes should be used for grounding purposes and should not be used for mounting the modules.
- A third-party grounding device that meets the code requirements for the electrical equipment at the installation site can be used for module grounding, but must follow the manufacturer's instructions.

**7 Maintenance**

PV modules must be inspected and maintained regularly, especially during the warranty period, which is the responsibility of the user. This helps to find and figure out problems in time and ensure the safe and effective operation of the PV system.

**7.1 Routine Inspection**

PV modules in PV arrays should be inspected regularly for damages, such as glass breakage, cable breakage,



## ASTRONERGY

---

junction box damage, cell cracks, and backsheet breakage and other factors that cause functional and safety failures of PV modules. If any of the above problems occurs, the supplier should be notified to replace the broken module with a new one of the same type in time.

It is recommended to perform preventive inspection every 6 months and not to replace the components of PV modules without authorization. When conducting inspection or maintenance in term of the electrical and mechanical performance, it is recommended that qualified professionals perform the work to avoid electric shock or personal injury.

Take routine maintenance to keep PV modules free of snow, bird droppings, seeds, pollen, leaves, branches, dust, stains, etc.

### 7.2 PV module cleaning

Astronergy recommends an installation tilt angle of no less than 10°, so that the dust on surface can be easily carried away by the rainwater while raining, in order to reduce the number of times of clean. Moreover, it can also help the water on the surface of the PV module to

flow away. If there is a large accumulation of dirt on the PV module surface that has seriously affected the power production, the module can be rinsed with water without detergent, and use a gentle sponge or brush to clean the surface during the cooler hours of the day. Dust must not be scraped or wiped off under dry conditions as this may result in tiny scuff marks. For snow removal, the PV module surface can be cleaned with a brush with soft bristles. For more details on cleaning and maintenance, please refer to the PV Module Cleaning Manual.

### Modified version and date

- Rev 1.0, released in September 2022.
- Rev 1.1, released in January 2023.
- Rev 1.2, released in June 2023.
- Rev 1.3, released in December 2023.
- Rev 1.4, released in July 2024.
- Rev2.1, released in October 2024.
- Rev2.2, released in January 2025.

### GLOBAL SERVICE CENTERS

Chint New Energy Technology Co., Ltd.

Add: No. 1 Jisheng Road, Jianshan New Zone Haining 314415 Zhejiang P.R. China

Web: [www.astronergy.com](http://www.astronergy.com)

Technical Team Email: GTS.astro@Astronergy.com